

# Lamps, Operator

An overview..

By Chris Bisailion VE<sub>3</sub>CBK and Louis Meulstee PA<sub>0</sub>PCR

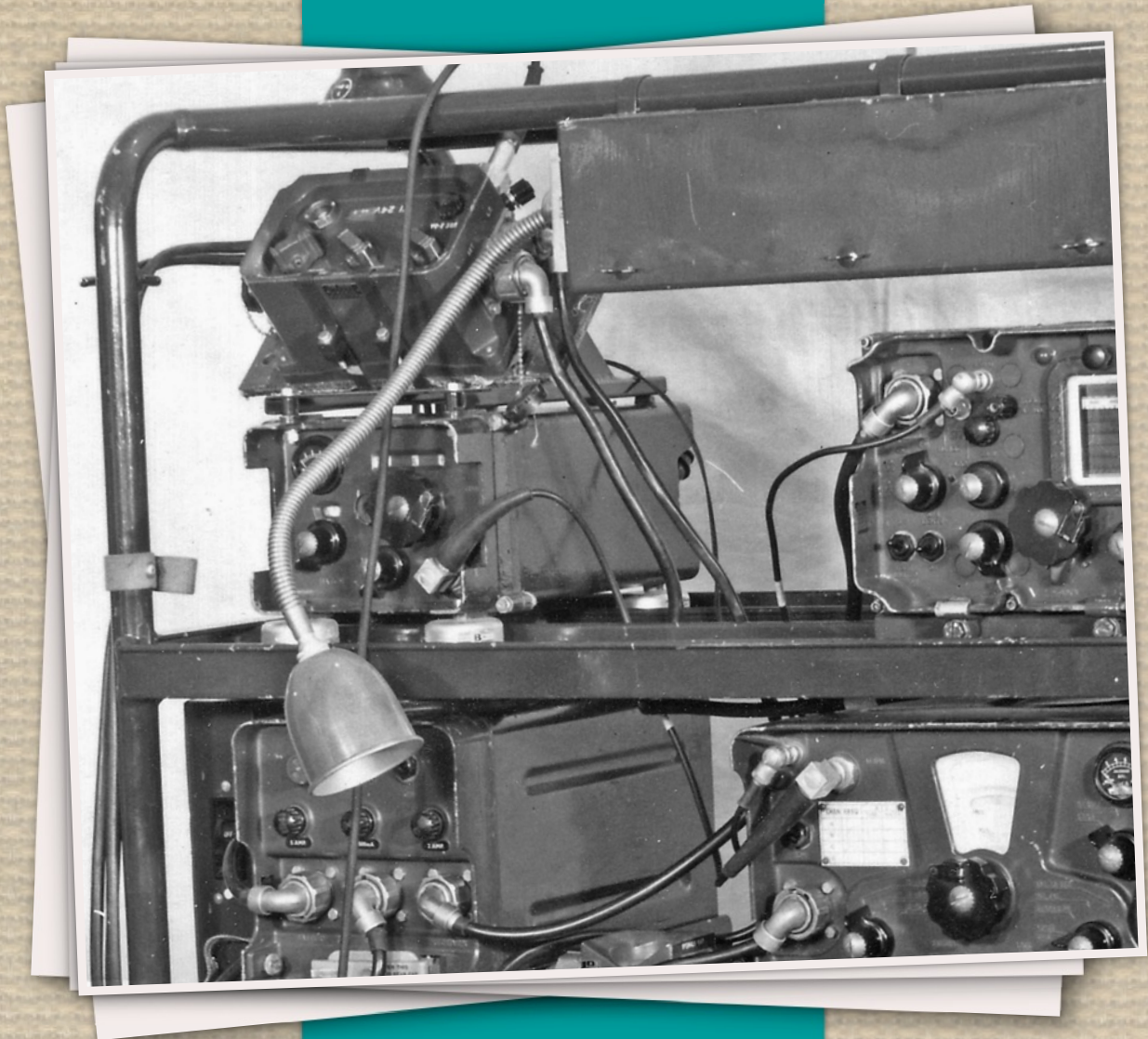

Small operator lamps were issued with most British (and Commonwealth) Army vehicle and ground radio stations, normally powered directly from a socket fitted on the front panel of the set. This overview shows the presently known versions and variations.

Cover and layout: Louis Meulstee PA0PCR  
Cover illustration: Lamps Operator No. 3 in Station Radio C11/R210  
fitted in air-transportable container.

The cover artwork and layout of this overview was prepared in Serif Pageplus X6 using Arial and Formal 436 BT fonts. The scanned illustrations and photos were enhanced and prepared with the use Adobe Photoshop. The finished publication was directly converted into PDF format.

Version 3.1  
First published April 2013.  
Amended January 2014.  
© Louis Meulstee PA0PCR  
Ottersum  
The Netherlands  
info@wftw.nl  
www.wftw.nl

#### **About this publication.**

Small operator lamps were issued with most British (and Commonwealth) Army vehicle and ground radio stations, normally powered directly from a socket fitted on the front panel of the set. This overview shows the presently known versions and variations.

This publication was stimulated by Chris Bisailion VE3CBK who asked me to identify a couple of early 'Lamps Operator' from his collection. Remembering that these particular lamps were in my modest collection, and in spite of the bitter coldness in the garage where I had them stored, I managed to locate the box and thus able to give a positive reply. Seeing all the variations in the box and knowing that Chris had also a good selection in his collection, we decided to compile a small illustrated list, just for our personal use. This became the main core of this overview. Eventually others contributed to the list, and at that stage I decided to compile this overview for the benefit of anyone interested in this subject. We are grateful to the contribution of photos, scans and support from Tony Bell, Australia and Mike Willenbroek, Holland.

Newly found material may be included in later published versions of this publication. This will be announced in the 'What's New' and 'Downloads' pages on my website www.wftw.nl

Any additions to this list and remarks  
are appreciated at: louis@wftw.nl



April 2013





### Lamps Operator No. 1 ZA 4523

Used with Wireless Set No. 9. Requires Bulb 12V F. The lamp assembly plugs in the top of the socket of Connector Twin No. 17.

**Remarks/observations:** The pins were thinner than those of Lamps Operator No. 2, but otherwise both lamps were similar. Marked at the bottom with a large '1'.



Valve test panel R107 showing position of lamp socket.

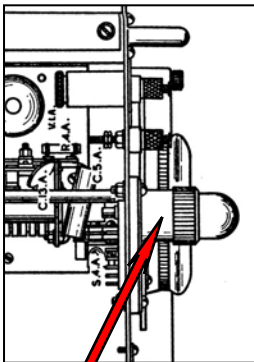

R208

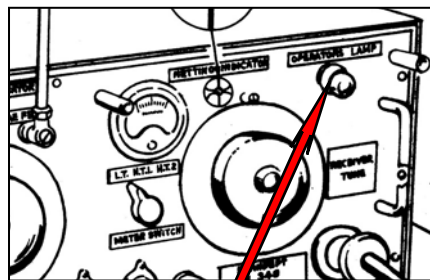

CN 348

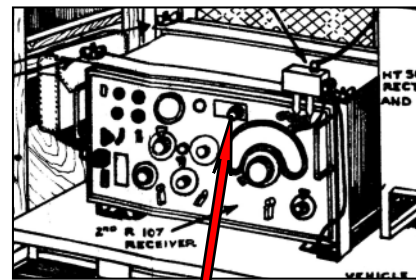

R107

### Lamps Operator No. 2 ZA 4524

Used With Wireless Set No. 11, R105, R107, R208, CN348. Required a Bulb 6V J (Bulb 6.5V T in R208) and fitted into a socket on the front panel. It was also issued with WS Nos. 12, 12HP and 33 complete station. Also used with Wireless Set No. 11 (Aust) and No. 11 (Cdn).

**Remarks/observations:** The pins were thicker than those of Lamps Operator No. 1, but otherwise both lamps were similar. Marked at the bottom with a large '2'.

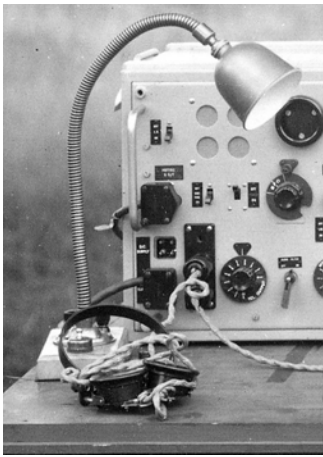

R 107

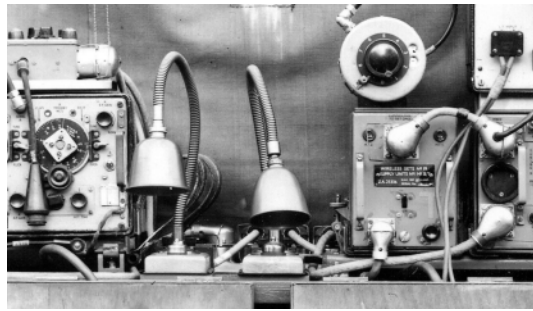

Wireless Station No. 19/19HP

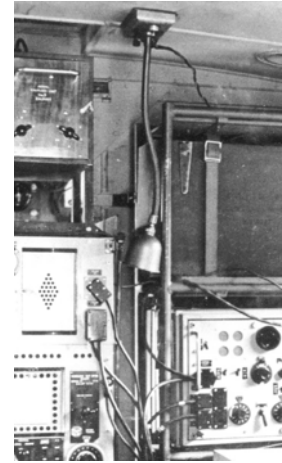

WS No. 33/R107



### Lamps Operator No. 3 ZA 4600

Used with Wireless Sets Nos. 12, 12HP, 19, 33, 53 vehicle stations and various other applications. **Remarks/observations:** This was principally a table or ceiling mounted lamp, not receiving its power direct from the set, but from the vehicle or installation battery. It could be fitted on a mounting plate known as Lamps Operator No. 3, Slides, ZA 3291.



### Lamps Operator No. 4 ZA 1906

Used with fixed and semi-mobile stations. Intended for mains operated 240V bulbs. **Remarks/observations:** Believed to be an adoption of a commercial lamp having art deco elements. Also recorded as having been used with Reception Set R106 in AA Command Post. Note the engraved broad arrow below the identification plate.

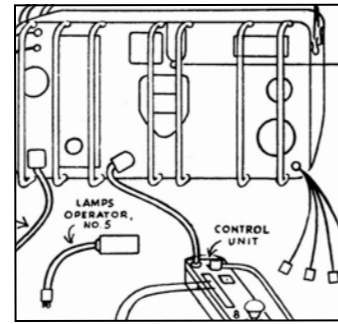
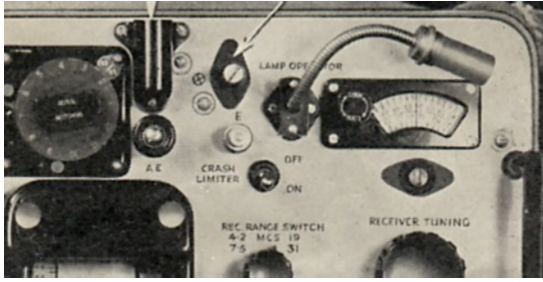

### Lamps Operator No. 5 ZA 10741

Used with Wireless Set No. 21. Later replaced by Lamps Operator No. 6A.

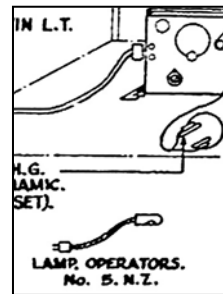

### Lamps Operator No. 5 N.Z. GA 104

Used with New Zealand Wireless Set ZC1 Mk.I and Mk.II. Based on, but otherwise differing in most aspects to the British version.



British version



Canadian version (Also known as RCA-110077-1 and NSN 5820-21-108-6221)

### Lamps Operator No. 6 ZA 11521

Used with all versions of Wireless Set No. 19 and No. 19 (Cdn). The threaded plug at the end of the wire screws in place of the pilot lamp on the supply unit.



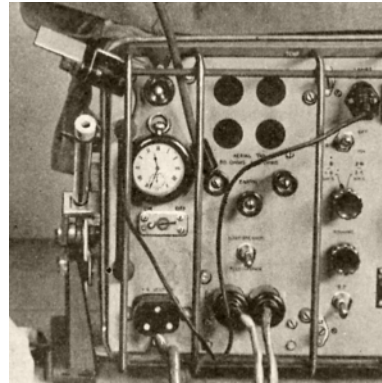
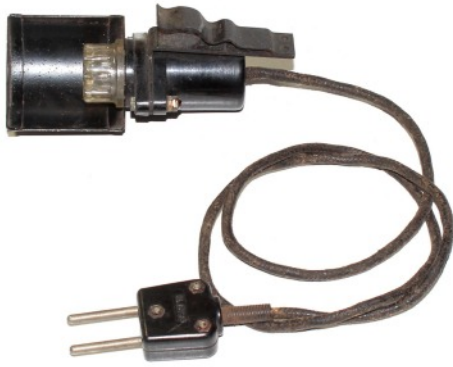

### Lamps Operator No. 6A ZA 12645

Used with Wireless Sets Nos. 21, 22, S.R.O.S., S.R.H.Q. and Reception Sets R109, R308. Also used with Wireless Set No. 22 (Aust) and 122 (Aust).



### Lamps Operator No. 6A Mk.I/I ZA 29311

Tropicalised version of Lamps Operator No. 6A. Also known as Lamps Operator No. 6AT. Use is similar to No. 6A.

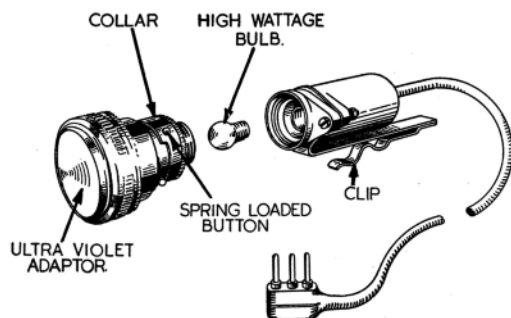

### Lamps Operator No. 6B ZA 28365 (NSN 6230-99-942-7881)

Used with Wireless Set No. 62 and Station Radio C12. **Remarks/observations:** The Wireless Set No. 62 working instructions showed a UV adaptor that could be fitted on this lamp, but it is doubtful whether this adaptor ever was issued.

## Lamps Operator No. 1 ZA/C 4523

Used with Canadian Wireless Set No. 9. It is similar to the British ZA 4523.

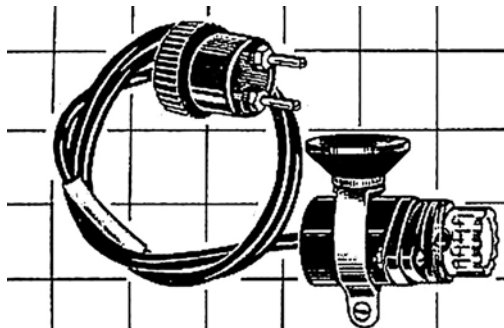

## Lamps Operator No. C1 ZA/C 4412

Used with Wireless Set No. 52. **Remarks/observations:** There were no apparent differences between the Lamps Operator No. C1 and No. C6. "...may be incorrectly labelled 'Lamp Operator's C6 ZA/C00065'..." (A note from WS (Cdn) No. 52 EMERs)

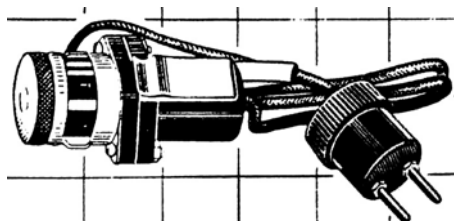

## Lamps Operator No. C2 ZA/C 2092

Used with Wireless Set (Cdn) No. 29.

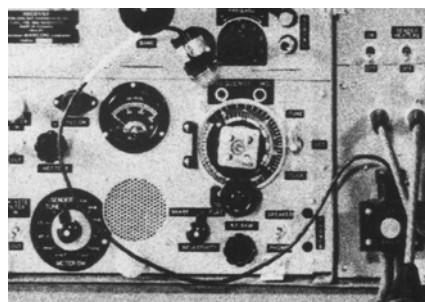
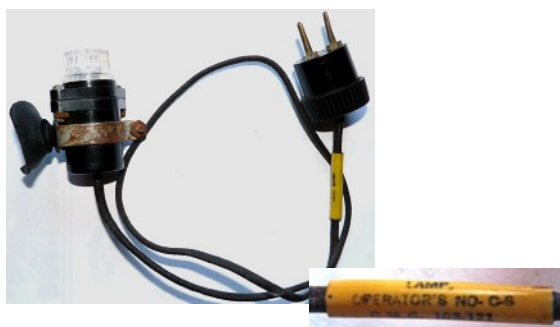

## Lamps Operator No. C6 ZA/C 00065

Used with Wireless Set (Cdn) No. 52. **Remarks/observations:** There were no apparent differences between the Lamps Operator No. C1 and No. C6. "...may be incorrectly labelled 'Lamp Operator's C6 ZA/C00065'..." (A note from WS (Cdn) No. 52 EMERs)

### Lamps Operator No. 6 (Aust)

Used with Australian Wireless Set No. 153 in particular the associated Reception Set (Aust) No. 8. **Remarks/observations:** The lamp is a standard operator lamp No. 6 with two flying leads for connecting to the two terminals fitted on the front panel of the receiver.

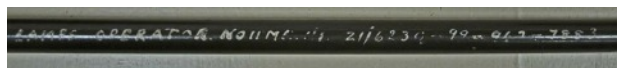
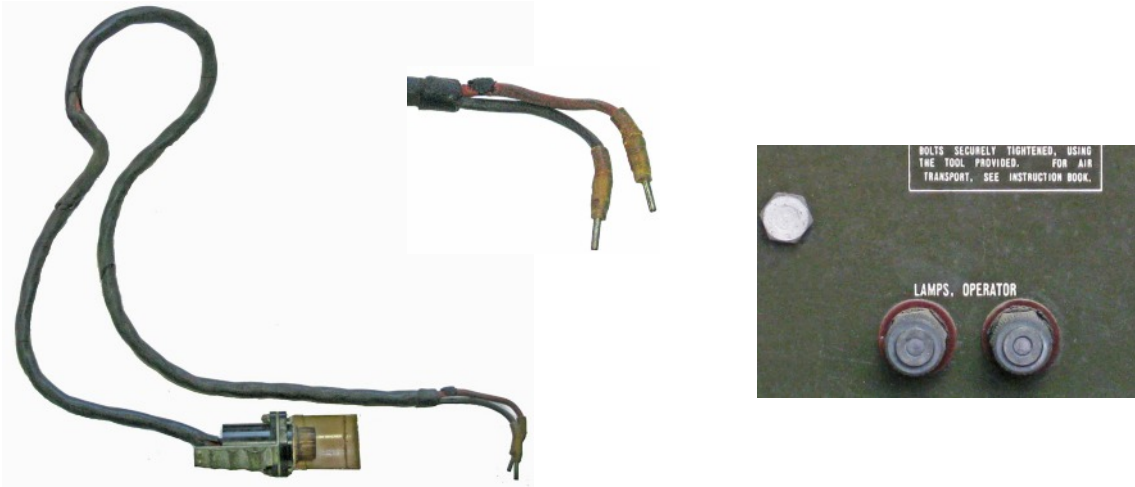

### Lamps Operator No. 10 Mk.1/1 and 11 Mk.1/1

Lamps Operator No. 10 Mk.1/1 (ZA 31038) was fitted to clamp and arm marked Lamps Operator No. 11 Mk1/1 (Z1/6230-99-943-7883). This might be at first glance an odd combination but as several samples were encountered this assembly appears to be original.



### Unknown Lamps Operator

This variation of Lamps Operator No. 2 is unmarked. It had a different top cover.



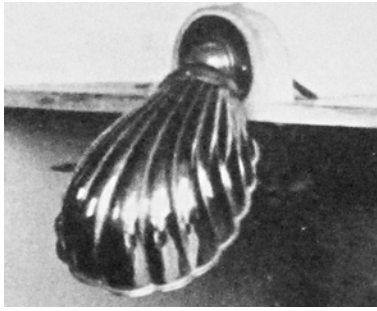

Close up and general view of an unknown type of lamp. Here seen fitted in an early Golden Arrow Mk .II receiver trailer. It was also used in other vehicles.



### Miscellaneous post-war lamps.

Several versions and variations of fixed mounted ceiling and wall mounted lamps have been encountered. These lamps were not specifically wireless items and normally part of a vehicle installation kit.

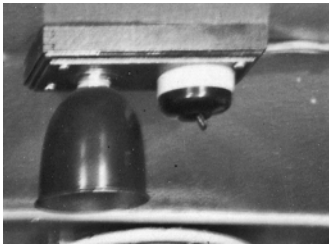

The armless ceiling lamp shown above and right was used in numerous wireless and line communication vehicles and trailers. It had similarities to and might be a modified version of Lamps Operator No. 3



### Lights desk adjustable 2 arm Dugdill type MSV/54

This articulated lamp, believed to be an adoption of a commercial product, was fitted in various post-war wireless trucks e.g. Truck 1-ton GS Wireless HP. (Left and below) Stores number X2/6230-99-942-6380.

